

**ACU-Jet Double6 Premium**  
**ACU-Jet Double6 Premium**



Beim Schruppen von Werkzeugstahl, rostfreiem Stahl oder gar Superlegierungen kommen viele Werkzeugsysteme schnell an ihre Grenzen. Speziell hierfür hat LMT Kieninger das Frässystem ACU-Jet Double6 überarbeitet und um die Wendeschneidplatte Ø 12 mm ergänzt.

Das Resultat ist ein Werkzeug, das maximale Stabilität und Prozesssicherheit bietet und durch die doppelseitige Verwendung der Schneidplatte, bis zu 12 Einsätze sind möglich, auch bei wirtschaftlicher Betrachtung punktet.

**Merkmale:**

- Doppelseitige Wendeschneidplatte für bis zu 12 Einsätze
- Verdrehsicherheit der Schneidplatte für mehr Prozesssicherheit
- 4 Hochleistungssorten für die Bearbeitung von ISO P, M, K und S
- 2 unterschiedliche Geometrien stehen zur Verfügung:  
R = schwere Schruppoperationen, stabile Schneidkante  
M = mittlere Bearbeitungen, positive Geometrie

Many tool systems quickly reach their limits when roughing tool steel, stainless steel or even superalloys. LMT Kieninger has redesigned the ACU-Jet Double6 specifically for this purpose and has added the Ø 12 mm indexable insert.

The result is a tool which offers maximum stability and process reliability. Due to double-sided use of the cutting inserts up to 12 applications per inserts are possible, the tool is highly efficient.

**Features:**

- Double-sided indexable insert for up to 12 applications
- Antitwist protection of the insert for more process reliability
- 4 high performance grades for machining ISO P, M, K and S
- 2 different geometries are available:  
R = heavy roughing operations, stable cutting edge  
M = medium machining, positive geometry

**Anwendungsbeispiel**  
**Application example**



**Unterstempel**  
**Lower punch**

**Maschine Machine:**

Droop & Rein mit with Fidia C20

**Werkzeug Tool:**

FCC R12.042AN40-05-I-Double6

**Wendepatte Insert:**

RNLU 1204MO-R

**Schneidstoff Cutting material:**

LCPK30M

**Werkstoff Material:**

1.2333 (G59CrMoV18-5)

**Schnittwerte Cutting data:**

$v_c = 140$ (175) m/min	$a_e = 26$ mm
$n = 1062$ (1327) min <sup>-1</sup>	$a_p = 1,2$ mm
$f_z = 0,5$ (0,9) mm	$Q = 83$ (186) cm <sup>2</sup> /min
$v_f = 2654$ (5971) m/min	

**Kühlung Coolant:**

Luft Air

**Ergebnis Result:**

Standzeit ca. 2 Stunden, wenig Verschleiß trotz überfräsen der Gushaut (Werte in Klammern sind ohne Gushaut)  
Tool life approx. 2 hours, low wear despite milling the cast skin (data in bracket without cast skin)

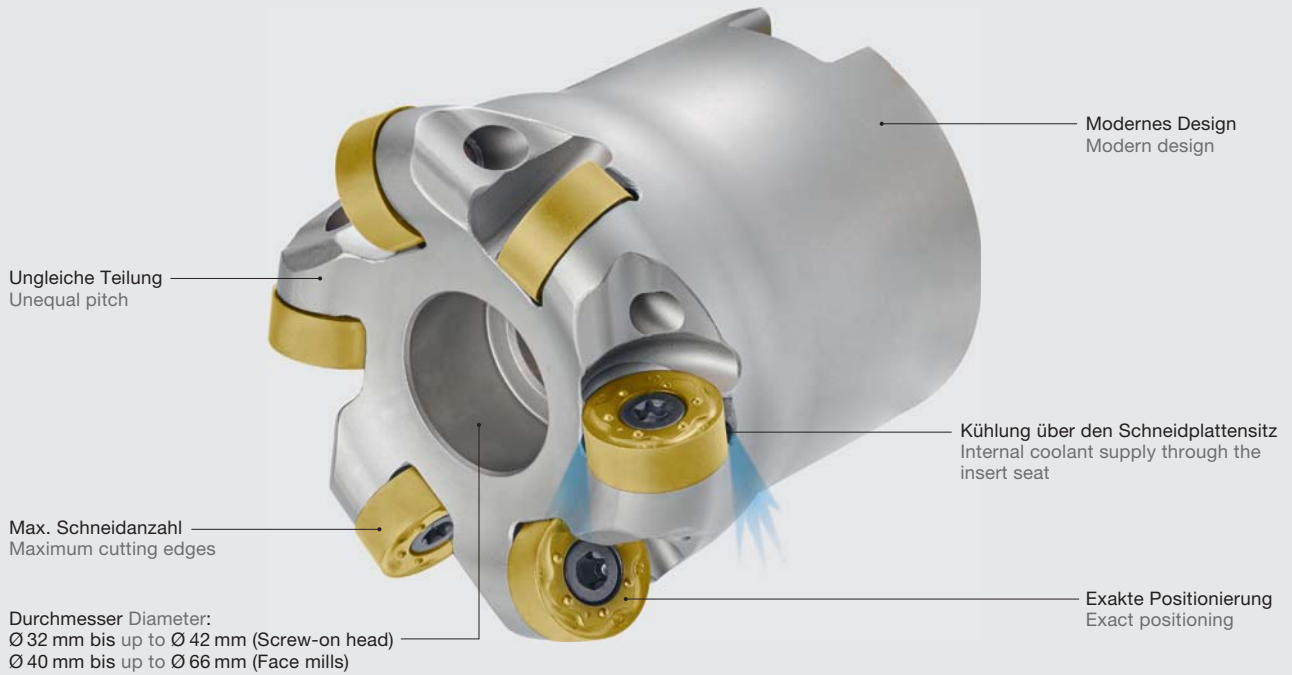

**Neuer Grundkörper**  
**New tool body**

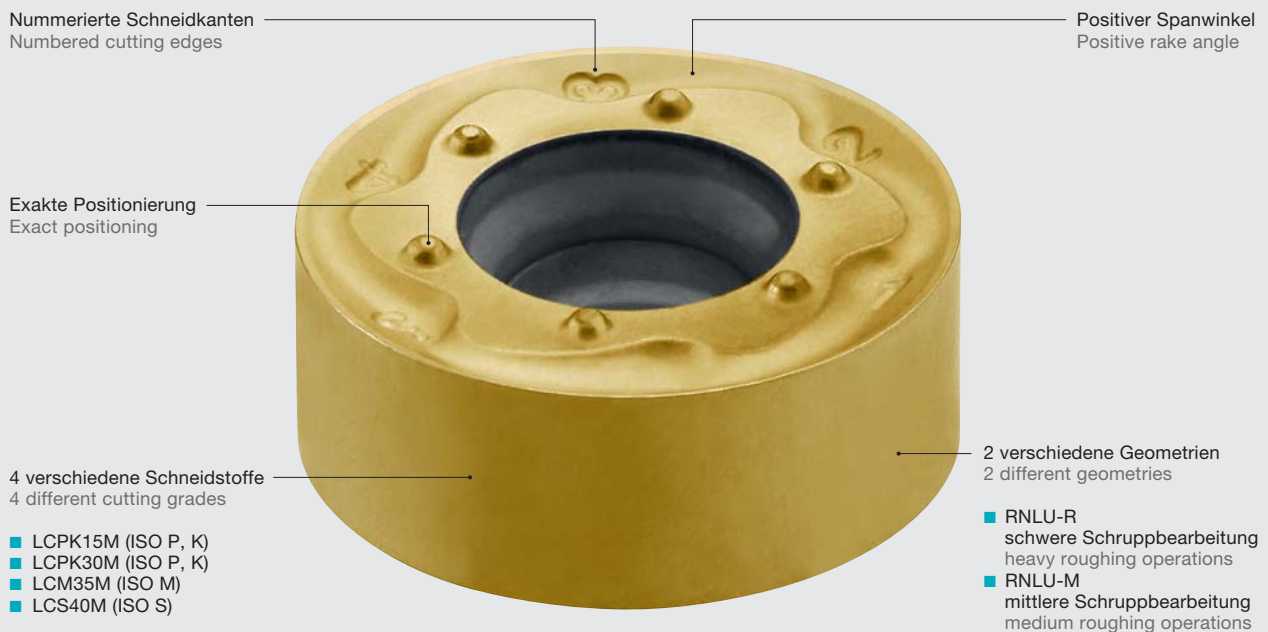

**Neue Wendeplatte Ø 12 mm**  
**New insert Ø 12 mm**

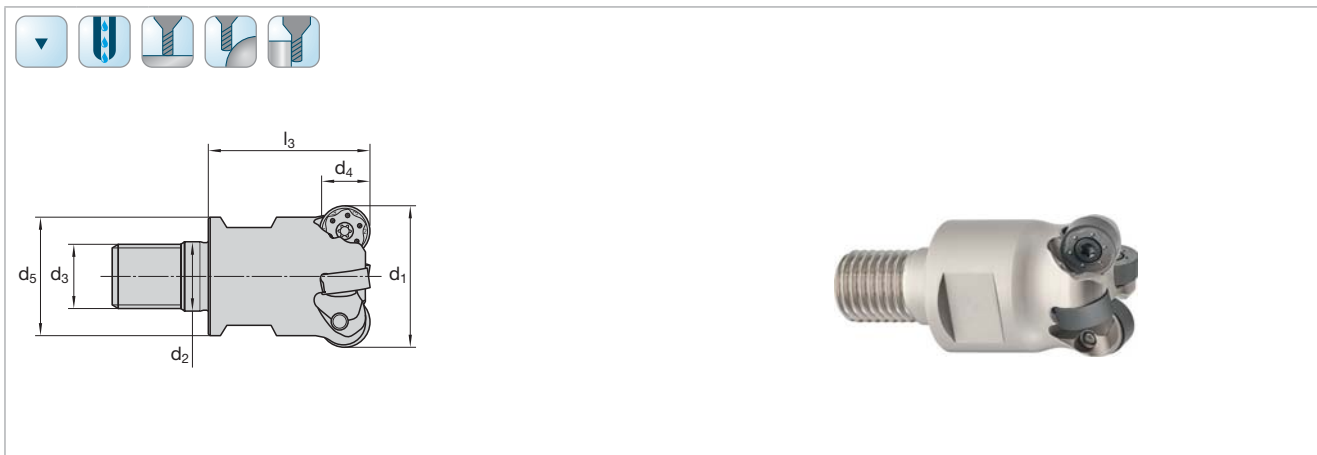





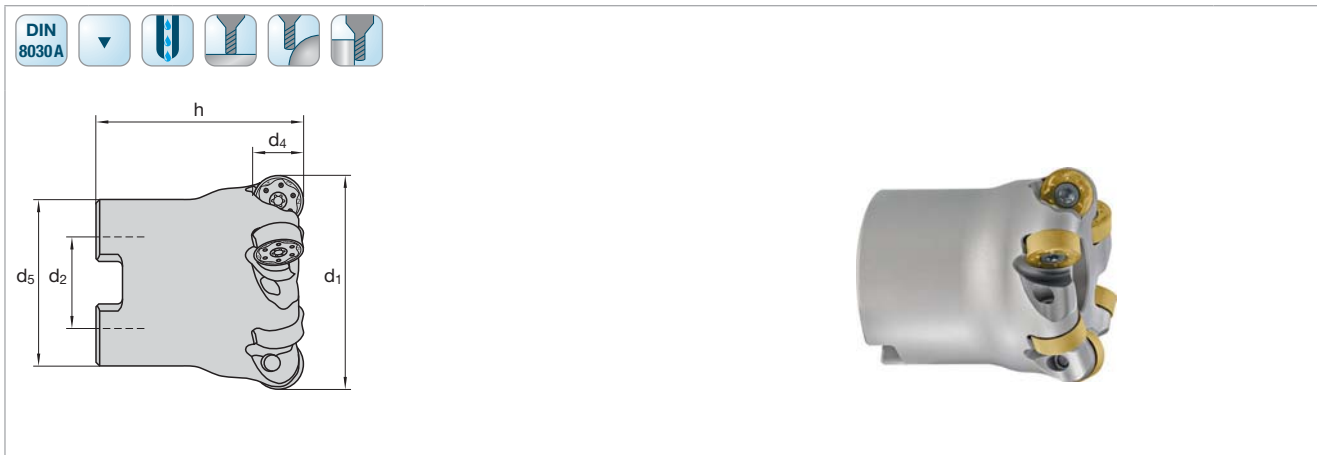

Katalog-Nr. Cat.-No.								FCC			
d <sub>1</sub>	d <sub>4</sub>	l <sub>3</sub>	d <sub>5</sub>	d <sub>3</sub>	d <sub>2</sub>	z	Ident No.	LMT-Code			
32	12	40	29	M16	17	4	7200034	ECC R12.032TH40-04-I-Double6	RN... 12	6119602	1048335 T15
35	12	40	29	M16	17	4	7255054	ECC R12.035TH40-04-I-Double6			
40	12	40	29	M16	17	5	7200035	ECC R12.040TH40-05-I-Double6			
42	12	40	29	M16	17	5	7200036	ECC R12.042TH40-05-I-Double6			

Schnittwertempfehlungen ab Seite 6  
 Recommendations for cutting data, refer to page 6

**ACU-Jet Double6 Premium**  
**Kopierfräser**  
 Copy cutters



Katalog-Nr. Cat.-No.								FCC			
d <sub>1</sub>	d <sub>4</sub>	h	d <sub>5</sub>	d <sub>2</sub>	z	Ident No.	LMT-Code				
42	12	40	36	16	5	7200037	FCC R12.042AN40-05-I-Double6	RN... 12	6119602	1048335 T15	
50	12	50	40	22	6	7200038	FCC R12.050AN50-06-I-Double6				
52	12	50	40	27	6	7200039	FCC R12.052AN50-06-I-Double6				
63	12	50	54	27	7	7200040	FCC R12.063AN50-07-I-Double6				
66	12	50	57	27	7	7200041	FCC R12.066AN50-07-I-Double6				

Schnittwertempfehlungen ab Seite 6  
 Recommendations for cutting data, refer to page 6

N = Anzahl der Schneidkanten N = Number of cutting edges		Schneidstoffsorten Cutting materials										Für Fräser For cutter					
		Ident No.															
ISO-Code		l	d	s	d <sub>1</sub>	r	LCS40M	LCM35M	LCKP20M	LCKP28M	LCP35M	LCKP30M	LCKP15M	LWNS10M	LCH05M	LBHK85M	Cat-No.
	RNLU 1204 MO-M	-	12	4,75	4,57	-	7207971	7207970									ECC FCC
	RNLU 1204 MO-R	-	12	4,75	4,57	-						7222375	7222374				
							<input type="checkbox"/>	<input type="checkbox"/>				<input checked="" type="checkbox"/>	<input checked="" type="checkbox"/>				<b>P</b>
							<input type="checkbox"/>	<input checked="" type="checkbox"/>				<input type="checkbox"/>	<input type="checkbox"/>				<b>M</b>
											<input type="checkbox"/>	<input checked="" type="checkbox"/>					<b>K</b>
											<input type="checkbox"/>	<input checked="" type="checkbox"/>					<b>N</b>
							<input checked="" type="checkbox"/>										<b>S</b>
																	<b>H</b>

■ = Hauptanwendung First choice  
□ = Nebenanwendung Alternative





**LMT Schneidstoffe**  
LMT cutting materials

Sorte Grade	Beschichtung Coating	Werkstoffe Material	Verschleißbeständigkeit Wear resistance										Beschreibung Description				
			01	05	10	15	20	25	30	35	40	45		50			
LCPK15M	Nanomold Black	P	■	■	■											HC-K10/K20 Nanomold Black Hochverschleißfeste beschichtete Fräsorte mit einer hohen Schneidkantenstabilität, dadurch besonders geeignet für das Schruppen und Semischlichten von legierten und unlegiertem Werkzeugstählen, hochfesten Werkstoffen und Gusseisen. Geeignet für die Trocken, Nass-, sowie MMS-Zerspanung. Highly wear-resistant, coated milling grade with maximum edge stability. Particularly suited for roughing and semi finishing of alloyed and non-alloyed tool steel, high-strength materials, and cast iron. Suitable for dry, wet and MMS chip machining.	
		M	□	□	□												
		K	■	■	■												
		N															
		S															
		H															
LCPK30M	Nanomold Gold	P				■	■	■								HC-K30 Nanomold Gold Hochverschleißfeste Fräsorte mit einer hohen Schneidkantenstabilität. Eignung für das Schruppen und Semi-Schlichten von legierten und unlegierten Werkzeugstählen, hochfesten Werkstoffen und Gusseisen. Besondere Eignung für die Trockenzerspanung. Wear-resistant milling grade with maximum cutting edge stability. Suitable for roughing and semi-finishing of alloyed and non-alloyed tool steel, high-strength materials, and cast iron. Ideal for dry machining.	
		M				□	□	□									
		K				■	■	■									
		N															
		S															
		H															
LCM35M	Nanomold Gold	P							□	□	□					HC-M35 Nanomold Gold Temperaturstabiler und zäher Schneidstoff für die Schruppbearbeitung von rost- und säurebeständigen Stählen, sowie von legierten und unlegiertem Werkzeugstählen. Durch die besonders nachbehandelte Beschichtung werden insbesondere Werkstoffverklebungen vermieden, wodurch maximale Standzeiten erreicht werden. Eignung für die Nass- und Trockenzerspanung. Temperature stable and tough cutting material for roughing stainless steel and acid-resistant steel and of alloyed and non-alloyed tool steel. Thanks to the special post-treated coating, material adhesion, in particular, is prevented, allowing maximum tool life to be reached. Suitable for wet and dry chip machining.	
		M							■	■	■						
		K															
		N															
		S									□	□	□				
		H															
LCS40M	Nanomold Red	P									□	□	□			HC-M40 Nanomold Red Äußerst zäher Schneidstoff für die Zerspanung von Titan und Inconel. Durch die besonders nachbehandelte Beschichtung werden insbesondere Werkstoffverklebungen vermieden, wodurch maximale Standzeiten erreicht werden. Eignung für die Nass- und Trockenzerspanung. Extremely tough cutting material for roughing of titanium and Inconel. Due to special post-treated coating, material adhesion in particular is prevented, allowing maximum tool life to be reached. Suitable for wet and dry chip machining.	
		M									□	□	□				
		K															
		N															
		S										■	■	■			
		H															

**ACU-Jet Double6 Premium**  
**Schnittwertempfehlungen**  
**Cutting data recommendations**

	<b>Werkstoff</b>	<b>Material</b>	<b>Werkstoff-Nr. Material No.</b>	<b>DIN Bezeichnung Alt DIN Description Old</b>	<b>R<sub>m</sub>/UTS (N/mm<sup>2</sup>)</b>	<b>DIN Bezeichnung Neu DIN Description New</b>
<b>P</b>	Unlegierter Baustahl + Automatenstahl	Plain carbon steel + free cutting steel	1.0570	St52-3	-700	S355J2G3
			1.1730	C45	-800	C45U
			1.0715	9SMn28	-700	11SMn30
			1.1191	Ck45	500-950	C45E
	Vergütungsstahl, mittelfest	Heat-treatment steel, medium strength	1.7225	42CrMo4	500-950	42CrMo4
			1.8159	51CrV4		51CrV4
	Stahlguss	Cast steel	1.0416	GS40	-950	GS40
	Einsatzstahl	Case hardening steel	1.7131	16MnCr5	-950	16MnCr5
	Rost- und säurebe- ständiger Stahl, ferritisch, martensitisch	Stainless steel, ferritic, martensitic	1.4006	X10Cr13	500-950	X12Cr13
			1.4104	X12CrMoS17		X14CrMoS17
			1.4122	X35CrMo17		X39CrMo17-1
	Vergütungsstahl, hochfest	Heat-treatment steel, high strength	1.7225	42CrMo4	950-1400	42CrMo4
	Nitrierstahl, vergütet	Nitriding steel, heat treated	1.6580	30CrNiMo8		30CrNiMo8
			1.8504	34CrAl6	950-1400	34CrAl6
	Werkzeugstahl	Tool steel	1.2344	X40CrMoV5.1	-900	X40CrMoV5-1
			1.2379	X155CrVMo12 1	-950	X153CrMoV12-1
1.2316			X38CrMo16	-1100	X38CrMo16	
1.2080			X210Cr12	950-1400	X210Cr12	
1.2312			40CrMnNiMoS8.6	-1150	40CrMnNiMoS8-6	
1.2343			X38CrMoV5 1	950-1400	X37CrMoV5-1	
1.2358			60CrMoV18-5	850-1000	60CrMoV18-5	
1.2714			55NiCrMoV7	1100-1350	55NiCrMoV7	
1.2311			40CrMnMo7	-1100	40CrMnMo7	
1.2738	45CrMnNiMo8.6.4	950-1150	45CrMnNiMo8-6-4			
<b>M</b>	Rost- und säurebe- ständiger Stahl, austenitisch	Stainless steel, austenitic	1.4301	X2CrNiMo17-12-2	500-950	X5CrNiMo18-10
			1.4404	X6CrNiMoTi17-12-2		X2CrNiMo17-12-2
			1.4571	X10CrNiMoTi18		X10CrNiMoTi18
	Rost- und säurebe- ständiger Stahl, martensitisch aushärtbar	Stainless steel, martensitic steel	1.2709	X3NiCoMoTi18-9-5	800-1000	X3NiCoMoTi18-9-5
1.4542			X5CrNiCuNb16-4		X5CrNiCuNb16-4	
1.4568	X7CrNiAl17-7		X7CrNiAl17-7			
<b>K</b>	Grauguss	Grey cast iron	0.6025	GG25	100-400 (120-260 HB)	EN-GJL-250
	Legierter Grauguss	Alloyed grey cast iron	0.6678	GGL-NiCr35 2	150-250 (160-230 HB)	EN-GJLA-XNiCr35-2
	Sphäroguss	Nodular cast iron	0.7060	GGG60	400-800	EN-GJS-600-3
			0.7070	GGG70L	(120-310 HB)	EN-GJS-700-2U
Temperguss	Malleable cast iron	0.8155	GTS55	350-700 (150-280 HB)	EN-GJMB-550-4	
<b>N</b>	Aluminium-Legierungen, kurzspanend	Aluminium alloys, short chipping	3.2581	G-AISi12	-400	G-IGK-AISi12
	Aluminium-Legierungen, langspanend	Aluminium alloys, long chipping	3.3535	AlMg3	-550	AlMg3
			3.4365	AlZnMgCu1,5		AlZnMgCu1,5
	Kupfer-Legierungen, kurzspanend	Copper alloys, short chipping	2.0402	MS58	-500	CuZn40Pb2
	Kupfer-Legierungen, langspanend	Copper alloys, long chipping	2.0320	MS63	300-500	CuZn37
			2.0975	CuAl10Ni		CuAl10Fe5Ni5-C
Thermoplaste	Thermoplastics		PVC	40-70	PVC	
Duroplaste	Duroplastics		Bakelit, Melamin	20-40	Bakelit, Melamin	
<b>S</b>	Titan-Legierungen, mittelfest	Titanium alloys, medium strength	3.7115	TiAl5Sn2,5	-950	TiAl5Sn2-5
			3.7164	TiAl6V4		Ti6AlV4
	Titan-Legierungen, hochfest	Titanium alloys, high strength	3.7174	TiAl6Sn2	900-1400	TiAl6V6Sn2
	Nickelbasis-Legierungen, mittelfest	Nickel based alloys, medium strength	2.4670	NiCr12Al6MoNb	-950	NiCr12Al6MoNb
Nickelbasis-Legierungen, hochwarmfest	Heat resistant nickel based alloys, high strength	2.4668	NiCr19Fe19NbMo	900-1400	Inconel 718 NiCr19Fe19Nb5Mo3	

Die angegebenen Schnittwerte sind Startwerte und müssen auf die vorhandenen Bedingungen abgestimmt werden.  
The cutting data indicated are starting values and must be adjusted to the prevailing conditions.

Schnittgeschwindigkeit Cutting speed $v_c$ (m/min)				Schruppen Roughing		
				RNLU..		
LCPK15M	LCPK30M	LCM35M	LCS40M	$f_z$	$a_p$	$a_e$
100-200	100-200			0,50-1,00	0,50-3,00	66 %
100-200	100-200			0,50-1,00	0,50-3,00	
100-200	100-200			0,50-1,00	0,50-3,00	
100-200	100-200			0,50-1,00	0,50-3,00	
100-200	100-200			0,50-1,00	0,50-3,00	
100-200	100-200			0,30-1,00	1,00-3,00	
100-200	100-200			0,30-1,00	1,00-3,00	
100-200	100-200	100-200	100-200	0,30-1,00	1,00-3,00	
		50-150	50-150	0,30-1,00	1,50-2,00	66 %
		50-150	50-150			
150-250	150-250			0,30-1,00	1,00-3,00	66 %
150-250	150-250			0,30-1,00	1,00-3,00	
150-250	150-250			0,30-1,00	0,50-2,00	
150-250	150-250			0,30-1,00	1,00-3,00	
				0,20-1,00	0,50-4,00	
				0,20-1,00	0,50-4,00	
				0,20-1,00	0,50-4,00	
				0,20-1,00	0,50-4,00	
				0,20-1,00	0,50-4,00	
				0,20-1,00	0,50-4,00	
		40-80	40-80	0,20-0,40	0,50-3,00	
		40-80	40-80	0,20-0,40	0,50-3,00	
		40-80	40-80	0,20-0,40	0,50-3,00	
		40-80	40-80	0,20-0,40	0,50-3,00	

© by LMT Tool Systems GmbH

Nachdruck, auch auszugsweise, ist nur mit unserer Zustimmung gestattet. Alle Rechte vorbehalten. Irrtümer, Satz- oder Druckfehler berechtigen nicht zu irgendwelchen Ansprüchen. Abbildungen, Ausführungen und Maße entsprechen dem neuesten Stand bei Herausgabe dieses Kataloges. Technische Änderungen müssen vorbehalten sein. Die bildliche Darstellung der Produkte muss nicht in jedem Falle und in allen Einzelheiten dem tatsächlichen Aussehen entsprechen.

Bildquellen: studio thomas schmitz

This publication may not be reprinted in whole or part without our express permission. All right reserved. No rights may be derived from any errors in content or from typographical or typesetting errors. Diagrams, features and dimensions represent the current status on the date of issue of this catalog. We reserve the right to make technical changes. The visual appearance of the products may not necessarily correspond to the actual appearance in all cases or in every detail.

Sources: studio thomas schmitz

**LMT Tools Niederlassungen und Servicestandorte**  
LMT Tools subsidiaries and service organisation

**Brasilien / Brazil**

LMT Tools Brasil  
Av. Cambacica 1200  
Módulo 11  
13097-160 São Paulo  
Telefon +55 19 982439910  
Telefax +55 11 55460476  
contato@lmt-tools.com

**China**

LMT China Co. Ltd.  
No. 9 Lanzhi Road  
Jiangning Development Zone  
211100 Nanjing  
Telefon +86 25 52128866  
Telefax +86 25 52106376  
lmt.cn@lmt-tools.com

**Deutschland / Germany**

LMT Tool Systems  
GmbH & Co. KG  
Heidenheimer Strasse 84  
73447 Oberkochen  
Telefon +49 7364 9579-0  
Telefax +49 7364 9579-8000  
lmt.de@lmt-tools.com

**Frankreich / France**

LMT Belin France S.A.S.  
Lieu dit „Les Cizes“  
01590 Lavancia  
Telefon +33 474 758989  
Telefax +33 474 758990  
belin@lmt-belin.com

**Großbritannien und Irland / United Kingdom and Ireland**

LMT UK Ltd.  
Unit 4202 Waterside Centre  
Solihull Parkway  
Birmingham Business Park  
B377YN Birmingham  
Telefon +44 121 7175830  
Telefax +44 121 7175838  
lmt.uk@lmt-tools.com

**Indien / India**

LMT (India) Private Limited  
Plot No. A-40/1  
Phase I, MIDC  
Chakan Industrial Area Village:  
Nighoje, Tal: Khed  
410501 Pune  
Telefon +91 2135614900  
Telefax +91 42337704  
sales@lmt-tools.co.in

**Korea**

LMT Korea Co. Ltd.  
Room 1212  
Anyang Trade Center  
161 Simin-daero, Dongan-Gu  
Anyang-Si  
431-817 Gyeonggi-Do  
South Korea  
Telefon +82 31 3848600  
Telefax +82 31 3842121  
lmt.kr@lmt-tools.com

**Mexiko / Mexico**

LMT Tools Mexico, SA de CV  
Adolfo Prieto No. 1638  
Colonia Del Valle Sur  
03100 Mexico, DF  
Telefon +52 55 40000653  
Telefax +52 44 22215555  
info@lmt.com.mx

**Rumänien / Romania**

LMT Tool Systems RO SRL  
Business Center Sibiu  
Camera 301, Etaj 3  
Str. Sibiului nr. 2  
557260 Selimbar, Sibiu  
Telefon +40 269 246092  
Telefax +40 269 560614  
lmt.ro@lmt-tools.com

**Russland / Russia**

LLC LMT Tools  
Serebryanicheskaya nab., 27  
109028 Moscow  
Telefon/Telefax +7 495 2807352  
info@lmt-russia.ru

**Spanien / Spain**

LMT Tool Systems GmbH  
Sucursal en España  
C/Agricultura local no.12  
planta 1 no. 16-18  
08320 El Masnou  
Telefon +34 937127435  
Telefon/Telefax +34 935407002  
jrodriguez@lmt-tools.com

**Tschechische Republik und Slowakei / Czech Republic and Slovakia**

LMT Czech Republic s.r.o.  
Dusikova 3  
63800 Brno-Lesná  
Telefon +420 548 218722  
Telefax +420 548 218723  
lmt.fette@iol.cz

**USA**

**Kanada / Canada**  
LMT USA Inc.  
1081 S. Northpoint Blvd.  
Waukegan, IL 60085  
Telefon +1 847 3621560  
Telefax +1 847 4731934  
lmt.us@lmt-tools.com

**Internationale Vertriebsgesellschaft / International sales organisation**

**LMT Tool Systems**

**GmbH & Co. KG**  
Heidenheimer Strasse 84  
73447 Oberkochen,  
Deutschland  
Telefon +49 7364 9579-0  
lmt.de@lmt-tools.com  
www.lmt-tools.com

**Center of Competence Europe**

**LMT Fette Werkzeugtechnik**

**GmbH & Co. KG**  
Grabauer Strasse 24  
21493 Schwarzenbek,  
Deutschland  
Telefon +49 4151 12-0  
info@lmt-fette.de  
www.lmt-tools.com

**Center of Competence USA**

**LMT USA Inc.**  
1081 S. Northpoint Blvd.  
Waukegan, IL 60085  
Telefon +1 847 3621560  
Telefax +1 847 4731934  
lmt.us@lmt-tools.com  
www.lmt-tools.com

**Center of Competence India**

**LMT (India) Private Limited**  
A-40/1, Chakan Industrial Area,  
MIDC Phase – 1,  
Village – Nighoje,  
Tal. – Khed, Dist. – Pune,  
410501 Maharashtra, India  
Telefon +91 2135 614900  
sales@lmt-tools.co.in  
www.lmt-tools.com

**Center of Competence China**

**LMT China Co. Ltd.**  
No. 9 Lanzhi Road,  
Jiangning Development Zone  
211100 Nanjing, China  
Telefon +86 25 52128866  
lmt.cn@lmt-tools.com  
www.lmt-tools.com

**LMT Belin France S.A.S.**

Lieu dit „Les Cizes“  
01590 Lavancia  
Frankreich  
Telefon +33 474 758989  
Telefax +33 474 758990  
info@lmt-belin.com  
www.lmt-belin.com

**LMT Kieninger GmbH**

Vogesenstrasse 23  
77933 Lahr  
Deutschland  
Telefon +49 7821 943-0  
Telefax +49 7821 943213  
info@lmt-kieninger.com  
www.lmt-kieninger.com

**LMT Fette Werkzeugtechnik GmbH & Co. KG**

Grabauer Strasse 24  
21493 Schwarzenbek  
Deutschland  
Telefon +49 4151 12-0  
Telefax +49 4151 3797  
info@lmt-fette.com  
www.lmt-fette.com

**LMT Onsrud LP**

1081 S. Northpoint Blvd.  
Waukegan, IL 60085  
USA  
Telefon +1 847 3621560  
Telefax +1 847 4731934  
info@onsrud.com  
www.onsrud.com

LMT Tools

**BELIN  
FETTE  
KIENINGER  
ONSRUD**

